

Network Video Recorder

NVR302-E-B Series



Key Features

- Support Ultra 265/H.265/H.264 video formats
- 9/16-channel input
- Third-party IP cameras supported with ONVIF conformance: Profile S, Profile G, Profile T
- Support 1-ch HDMI, 1-ch VGA, HDMI at up to 4K (3840x2160) resolution
- HDMI and VGA independent outputs provided
- Up to 12 Megapixels resolution recording
- 2 SATA HDDs, Up to 6TB for each disk
- Various fisheye dewarping modes for live view and playback for both web interface and GUI
- ANR technology to enhance the storage reliability when the network is disconnected
- Support cloud upgrade

Specifications

Model	NVR302-09E-B	NVR302-16E-B
Video/Audio Input		
IP Video Input	9-ch	16-ch
Two-way Audio Input	1-ch, RCA	
Network		
Incoming Bandwidth	320Mbps	
Outgoing Bandwidth	180Mbps	320Mbps
Remote Users	128	
Protocols	P2P, UPnP, NTP, DHCP, PPPoE	
Video/Audio Output		
HDMI/VGA Output	HDMI: 4K (3840x2160)/60Hz, 4K (3840x2160)/30Hz, 1920x1080p/60Hz, 1920x1080p/50Hz, 1600x1200/60Hz, 1280x1024/60Hz, 1280x720/60Hz, 1024x768/60Hz VGA: 1920x1080p/60Hz, 1920x1080p/50Hz, 1280x1024/60Hz, 1280x720/60Hz, 1024x768/60Hz	
Recording Resolution	12MP/8MP/6MP/5MP/4MP/3MP/1080p/960p/720p/D1/2CIF/CIF	
Audio Output	1-ch, RCA	
Synchronous Playback	9-ch	16-ch
Corridor Mode Screen	3/4/5/7/9	3/4/5/7/9/10/12/16
Decoding		
Decoding format	Ultra 265, H.265, H.264	
Live View/Playback	12MP/8MP/6MP/5MP/4MP/3MP/1080p/960p/720p/D1/2CIF/CIF	
Capability	3 x 12MP@25, 4 x 4K@30, 9 x 4MP@25	3 x 12MP@25, 4 x 4K@30, 9 x 4MP@25, 16 x 1080p@30
Hard Disk		
SATA	2 SATA interfaces	
Capacity	up to 6TB for each disk	
External Interface		
Network Interface	2 RJ45 10M/100M/1000M self-adaptive Ethernet Interfaces	
Serial Interface	1 x RS485	
USB Interface	Front panel: 1 x USB2.0 Rear panel: 1 x USB2.0, 1 x USB3.0	
Alarm In	8-ch	
Alarm Out	2-ch	
General		
Power Supply	12V DC Power Consumption: ≤ 12 W (without HDD)	
Working Environment	-10°C~+ 55°C (+14°F~+131°F), Humidity ≤ 90% RH (non-condensing)	
Dimensions (W×D×H)	380mm × 315mm ×53mm (15.0"× 12.4" ×2.1")	
Weight (without HDD)	≤ 2.48Kg (5.47lb)	

Dimensions

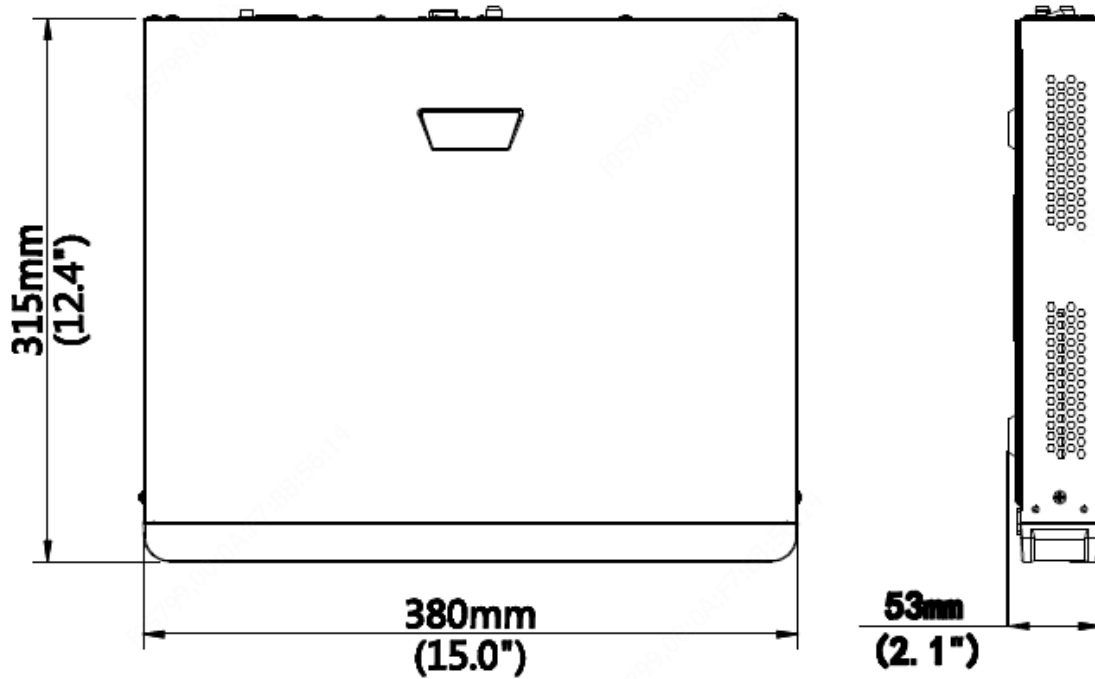

Rear Panel

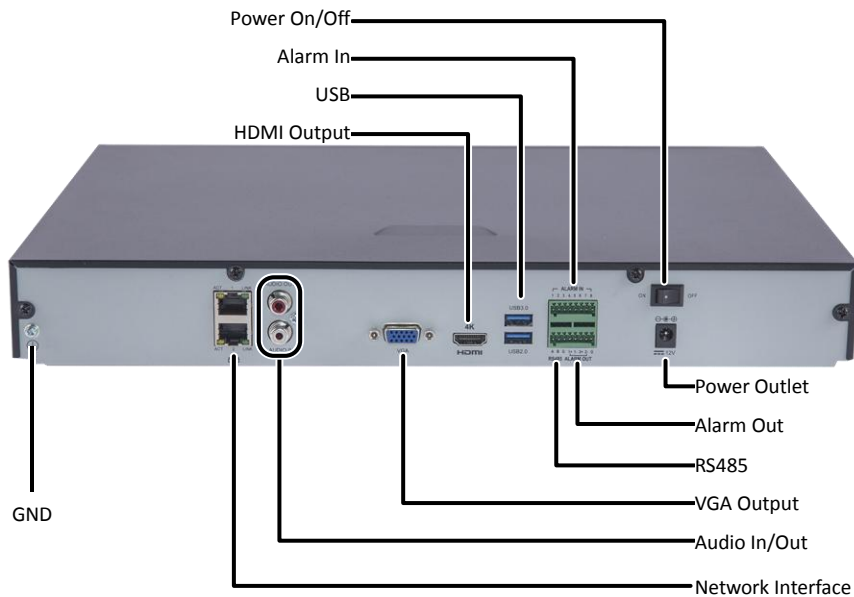

Zhejiang Uniview Technologies Co., Ltd.

Building No.10, Wanlun Science Park, Jiangling Road 88, Binjiang District, Hangzhou, Zhejiang, China

Email: overseasbusiness@uniview.com; globalsupport@uniview.com

<http://www.uniview.com>

©2019 Zhejiang Uniview Technologies Co., Ltd. All rights reserved.

* Product specifications and availability are subject to change without notice.